











Precise balances of PS/2Y are the response for the growing market demands concerning simple operation and maximum automation of the weighing process.

Measurement reliability and accuracy is assured by internal calibration triggered by time flow or temperature conditions.

Balances equipped in a new electronic modules and are operated using a touch panel covering a 5.7" colour graphic display. Y scales have implemented new easily operated software.

-  Counting pieces
-  Filling
-  Animal weighing
-  Density determination
-  Checkweighing
-  Percentage
-  Statistics
-  Formulation

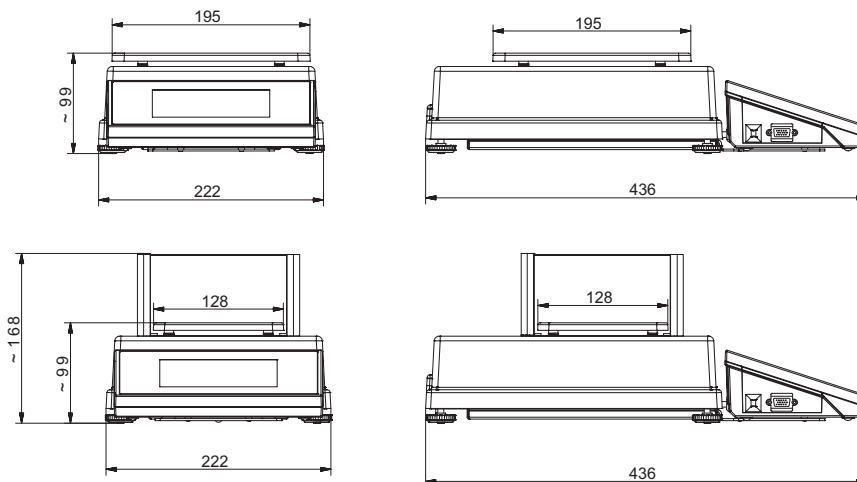

Technical data:

	PS 200/2000/2Y*	PS 250/2Y*	PS 450/2Y*	PS 600/2Y*	PS 750/2Y	PS 1000/2Y	PS 1500/2Y*	PS 2500/2Y*	PS 4500/2Y*	PS 6000/2Y*	PS 8000/2Y/1**
Max capacity	200/2000 g	250 g	450 g	600 g	750 g	1000 g	1500 g	2500 g	4500 g	6000 g	8000 g
Minimal load	20 mg	20 mg	20 mg	20 mg	20 mg	20 mg	500 mg	500 mg	500 mg	500 mg	500 mg
Readability	1/10 mg	1 mg	1 mg	1 mg	1 mg	1 mg	10 mg	10 mg	10 mg	10 mg	10 mg
Tare range	-2000 g	-250 g	-450 g	-600 g	-750 g	-1000 g	-1500 g	-2500 g	-4500 g	-6000 g	-8000 g
Linearity	±2/10 mg	±2 mg	±2 mg	±3 mg	±3 mg	±3 mg	±20 mg	±20 mg	±20 mg	±30 mg	15 mg
Repeatability	1/10 mg	1 mg	1 mg	1,5 mg	1,5 mg	1,5 mg	10 mg	10 mg	10 mg	15 mg	±20 mg
Pan size	128×128 mm						195×195 mm				
Stabilization time	2 s / 1,5 s	2 s	2 s	2 s	2 s	2 s	1,5 s	1,5 s	1,5 s	1,5 s	1,5 s
Sensitivity drift	2 ppm/°C in temperature +18 - +30 °C										
Working temperature	+15 - +30 °C										
Power supply	110 ÷ 230 V AC / 50 ÷ 60 Hz / 13,5 ÷ 16 V AC / 1,1 A										
Net weight/Gross weight	5/7,1 kg	4,1/6 kg	4,4/6,3 kg	4,4/6,3 kg	4,4/6,3 kg	4,4/6,3 kg	5/7,1 kg	5/7,1 kg	5/7,1 kg	5/7,1 kg	3,4/5,3 kg
Packaging size	570×325×225 mm										
Calibration	internal (automatic)						*verified balances			** external calibration	

Additional equipment:

Anti-vibration table	Standard mass
Printer Kafka, Epson, Citizen	Foot button for tare or print functions
Density determination kit for solids and liquids	Power adapter with battery and charger
PC keyboard	Antistatic cable
Ambient conditions module	Computer software: PW-WIN, RAD-KEY
Anti draught shield	Cable: P0136, P0151, P0108
LCD display	