

BALANTE ANALITICE SERIA AS/X

PARTNER



Balantele analitice din seria AS/X fac parte din categoria balantelor premium. Balantele sunt echipate cu **afisaj grafic iluminat si cu contrast reglabil**. Precizia masuratorii este garantata de sistemul de calibrare automata interna. Acesta calibreaza automat balanta la intervale de timp prestabilite, la simpla comanda a operatorului sau cand apar variatii de temperatura in mediu inconjurator.

Performantele seriei AS/X sunt confirmate prin certificatele metrologice si de calitate emise de catre organisme Europene.













Balantele AS/X sunt echipate cu optiunea de calibrare pipete si de asemenea pot fi prevazute cu sistemul de deschidere automata a usilor incintei de cantarire.

Balante pot transmite spre tiparire raportul procesului de calibrare in format GLP.

Utilizatorul are acces la incinta de masurare prin 3 usi culisante. Balantele sunt prevazute cu interfata RS 232.

Seria AS/X permite conectarea unui afisaj suplimentar.

Exista si posibilitatea de cantarire prin agatarea greutatii sub balanta. In acest mod se pot cantarii atat mase cu dimensiuni agabaritice cat si mase care pot crea campuri magnetice sau electrostatice cu influenta asupra sistemului electronic. Cantarirea sub balanta ofera si posibilitatea determinarii densitatii materialelor

-  Numarare piese
-  Dozare
-  Cantariri instabile
-  Determinare densitati
-  Verificare limite greutate
-  Cantarire procentuala
-  Rapoarte statistice
-  Retetare
-  Corectie densitate aer
-  Calibrare pipete
-  Proceduri GLP
-  Cantarire sub platan
-  Garantie 24 luni

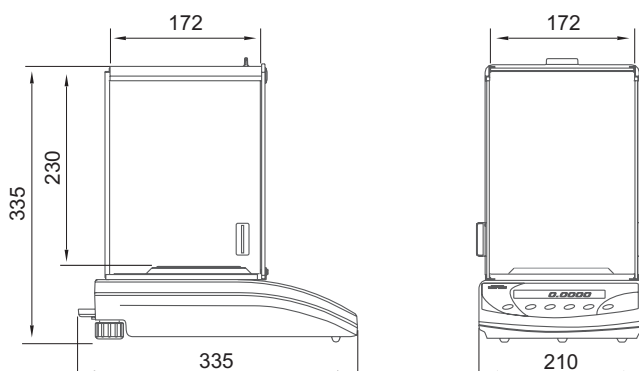

DATE TEHNICE :

	AS 110/X	AS 160/X	AS 220/X	AS 310/X
Capacitate maxima	110 g	160 g	220 g	310 g
Diviziune minima	0,1 mg	0,1 mg	0,1 mg	0,1 mg
Tara maxima	-110 g	-160 g	-220 g	-310 g
Domeniu de temperatura	+10° - +45°C			
Repetabilitate	0,1 mg	0,15	0,15	0,2
Liniaritate	± 0,3 mg	± 0,3	± 0,3	± 0,3
Sursa de alimentare	230V 50Hz AC / 11V AC 380 mA			
Tip calibrare	Interna automata			
Dimensiune platan	∅ 85 mm	∅ 85 mm	∅ 85 mm	∅ 85 mm

Echipamente optionale:

MASA ANTIVIBRATIE (DIN OTEL SAU INOX)	SUPORT PENTRU CANTARIRE SUB PLATAN
IMPRIMANTE TERMICA TIP "KAFKA"	AFISAJ SUPLIMENTAR LCD
IMPRIMANTE EPSON: TM-U220D, TM-U220B, TM-U220A	ACUMULATOR REINCARCABIL PENTRU ALIMENTARE ALTERNATIVA
KIT DENSITATE PENTRU SOLIDE SI LICHIDE	COMPUTER SOFTWARE: PW-WIN 2004 ; RAD-KEY 2000

Balantele sunt produse in **Comunitatea Europeana** si detin urmatoarele certificate de calitate si **Aprobari Metrologice** emise de prestigioase organisme Europene:

CE ; OIML ; TUV ; ISO 9001